

HERZ PIPEFIX

Pipes and fittings

Data sheet for PIPEFIX, Issue 0321

☑ Pipes

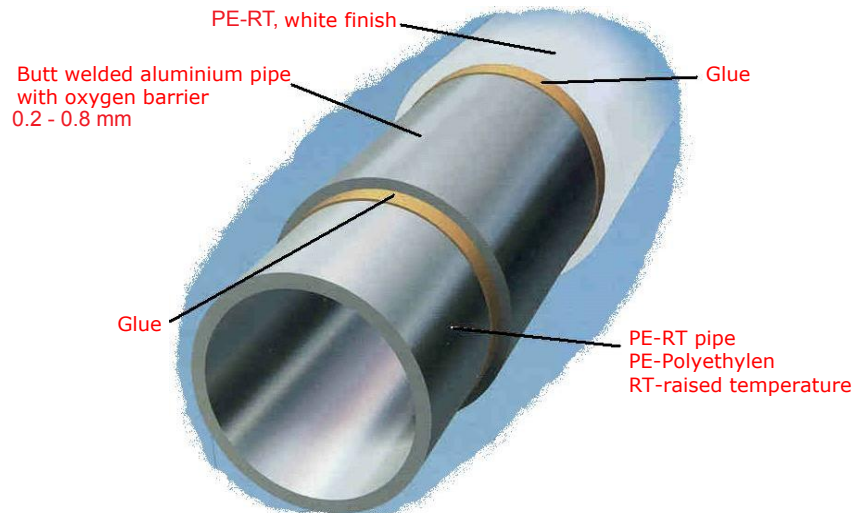

Plastic composite pipe PE-RT TYPE II / AL/ PE-RT TYPE II, multilayer pipe for complex installation tasks in heating, air conditioning and sanitary installations. System tested with HERZ PIPEFIX press and screw fittings or connectors. Delivered in coils or rods.

Pipe Ø x wall thickness [mm]	Aluminium number [mm]	PE-RT TYPE II / AL/ PE-RT TYPE II pipe coil	PE-RT TYPE II / AL/ PE-RT TYPE II pipe rod
10x1,3	0,2	3 C101 30	-
16x2	0,4	3 C160 20	3 C160 34
16x2	0,2	3 D160 20	3 C160 46
20x2	0,4	3 C200 20	3 C200 34
20x2	0,25	3 C200 30	3 C200 38
26x3	0,5	3 C260 30	3 C260 35
26x3	0,35	3 C260 40	3 C260 39
32x3	0,5	3 C320 30	3 C320 35
40x3,5	0,5	3 C400 30	3 C400 36
50x4,0	0,6	-	3 C500 40
63x4,5	0,8	-	3 C630 45

☑ Technical specification

Maximal operation temperature	70 °C-90 °C depending on the application class
Maximal operation temperature (max.1 year)	95 °C
Emergency operation temperature (max. 100 h)	100 °C
Minimum operation temperature *	- 20 °C
Maximal operation pressure	8-10 bar depending on the dimension
Maximal operation pressure (max. 1 year)	12 bar
Thermal conductivity	0,47 W/mK
Internal surface roughness	0,007 mm
Coefficient of linear expansion	0,023 mm/(mK)
Oxygen permeability	<0,1 g/m³d

☑ Plastic composite pipe PE-RT TYPE II / AL/ PE-RT TYPE II, with insulation

Pipe Ø x wall thickness [mm]	Aluminium thickness [mm]	Insulation thickness [mm]	Order number
16x2	0,2	6	3 D160 06
16x2	0,2	9	3 C160 44
16x2	0,2	13	3 D160 13
16x2	0,4	6	3 C160 06
16x2	0,4	9	3 C160 09
20x2	0,25	6	3 D200 06
20x2	0,25	9	3 D200 09
20x2	0,25	13	3 D200 13
20x2	0,4	6	3 C200 06
20x2	0,4	9	3 C200 09
26x3	0,35	6	3 D260 06
26x3	0,35	9	3 D260 09
26x3	0,35	13	3 D260 13
26x3	0,5	6	3 C260 06
26x3	0,5	9	3 C260 09
32x3	0,5	6	3 C320 06
32x3	0,5	9	3 C320 09

☑ Technical specification

Maximal operation temperature	70 °C-90 °C depending on the application class
Maximal operation temperature (max.1 year)	95 °C
Emergency operation temperature (max. 100 h)	100 °C
Minimum operation temperature *	- 20 °C
Maximal operation pressure	8 - 10 bar depending on the dimension
Maximal operation pressure (max. 1 year)	12 bar
Thermal conductivity	0,47 W/mK
Internal surface roughness	0,007 mm
Co- efficient of linear expansion	0,023 mm/(mK)
Oxygen permeability	<0,1 g/m³d
<u>Insulation LDPE foam with PE coating</u>	
Thermal conductivity	40 °C - 0,04 W/mK; 10 °C - 0,036 W/mK
Reaction to fire EN 13501-1	foam: BIs1d0; foam with coating 6 mm and 9 mm: CIs1d0 foam with coating 13 mm: DIs1d0
Water vapor diffusion number DIN 52615	$\mu \geq 16000$
Outer casing white, black lettering	

*** Attention at temperature <0 °C: pipe embedded firmly, no external mechanical stress (bending, permanent vibration, impact stress etc.), no ice formation in the pipe**

Plastic Composite Pipe PE-RT, Type II “Pipe in pipe” in protective tube

Pipe Ø x wall thickness [mm]	Aluminium thickness [mm]	Order number
16x2	0,2	3 C160 42
16x2	0,4	3 C160 33
20x2	0,25	3 C200 40
20x2	0,4	3 C200 33

☑ Linear Deformation of Pipes

There are three reasons for deformation of a pipe:

- Temperature change
- Internal pressure
- Chemical influences

Chemical influences in heating, cooling or potable water applications can be virtually excluded.
 The influence of internal pressure is very low, especially for the max. pressure of 10 bar.
 So only the linear deformation of pipes, precisely the expansion or contraction length of pipes, caused by temperature change will be regarded.

☑ Thermal expansion and contraction

The length change of a pipe depends on its material and on the amount of temperature difference. Each material has its own coefficient of linear thermal expansion (α), given in m/mK or in mm/mK.
 The expansion (or contraction) ΔL can be calculated with the formula:

$$\Delta L = L \times \alpha \times \Delta T$$

ΔL change of length of pipe [mm]

L length of pipe [m]

α coefficient of linear thermal expansion [mm/mK]

ΔT temperature difference [K]

In the table below you can see the coefficient of linear thermal expansion for several materials and the expansion of a pipe (length: 10 m) at a temperature difference of 60 K (installation: 10 °C, max. temperature of medium: 70 °C).

Material	Coefficient α [mm/mK]	Expansion of a pipe with 10 m at ΔT of 60 K [mm]
Steel	0.012	7.2
Stainless steel	0.010	6.0
Iron cast	0.012	7.2
Copper	0.017	10.2
Polyethylene (PE)	0.200	120
Polypropylene (PP)	0.180	108
Polybutylene (PB)	0.150	90
PipeFix multilayer pipe	0.023	13.8

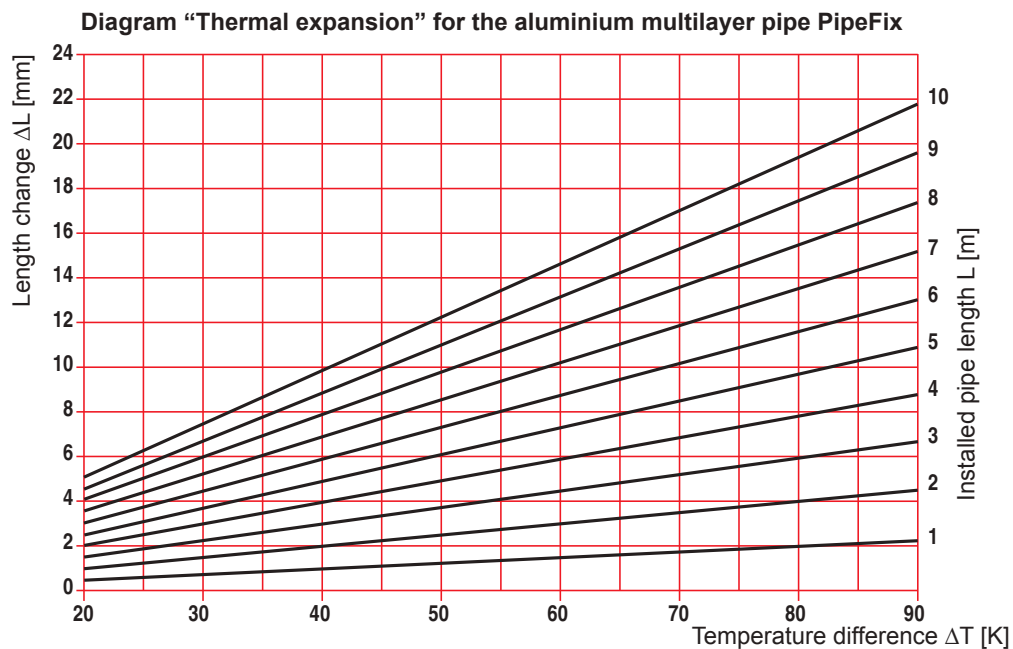

☑ Certificates

- ÖNORM EN ISO 21003
 - Application class 1, Tmax = 80 ° C, Max. Permissible operating pressure pD = 10bar
 - Application class 2, Tmax = 80 ° C, Max. Permissible operating pressure pD = 10bar
 - Application class 4, Tmax = 70 ° C, Max. Permissible operating pressure pD = 10bar
 - Application class 5, Tmax = 90 ° C, Max. Permissible operating pressure pD = 10bar (in DN 40 pD = 8bar)
- ÖVGW W 1.379
- DVGW DW - 8501BN0454
- ÜA - sign R-15.2.1-20-17036, WIEN-ZERT

☑ Force of expansion and shrinking

The length changes of plastic pipes are greater than the length changes of metal pipes. On the contrary, the forces caused by metal pipes are much higher than those caused by plastic pipes. Because of the little forces caused by plastic pipes, we don't have to observe the thermal length change, if the plastic pipes are embedded in gravel, plaster, screed or concrete.

Prevention of damages

We have to consider three types of assembly situations.

- Angled installation
- Junction
- Straight installation

☑ Angled installation

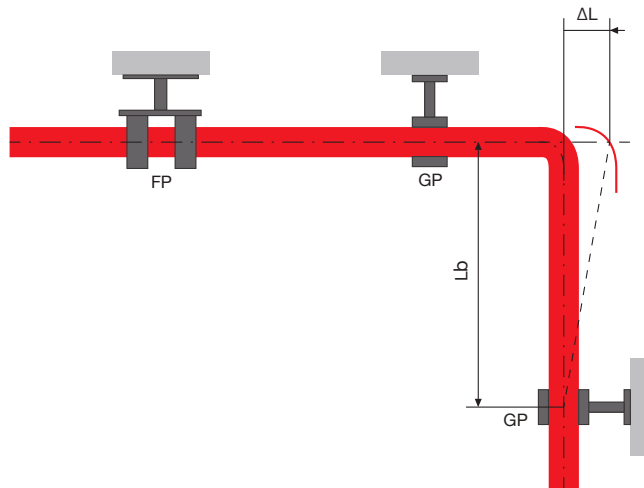

- FP clamp where pipe is fixed (fixed point)
- GP clamp where pipe can move (gliding point)
- Lb length for bending [mm]
- ΔL change of length of pipe [mm]

Depending on ΔL (formula and diagram see above) a minimum length is required Lb from the angle to the next clamp, to allow the pipe to move so that a break can be avoided. Lb can be calculated with the formula:

$$Lb = C \times \sqrt{(OD \times \Delta L)}$$

- Lb minimum length [mm]
- C constant (PipeFix: 33, PP 30, PE 26)
- OD outside diameter of the pipe [mm]
- ΔL change of length of pipe [mm]

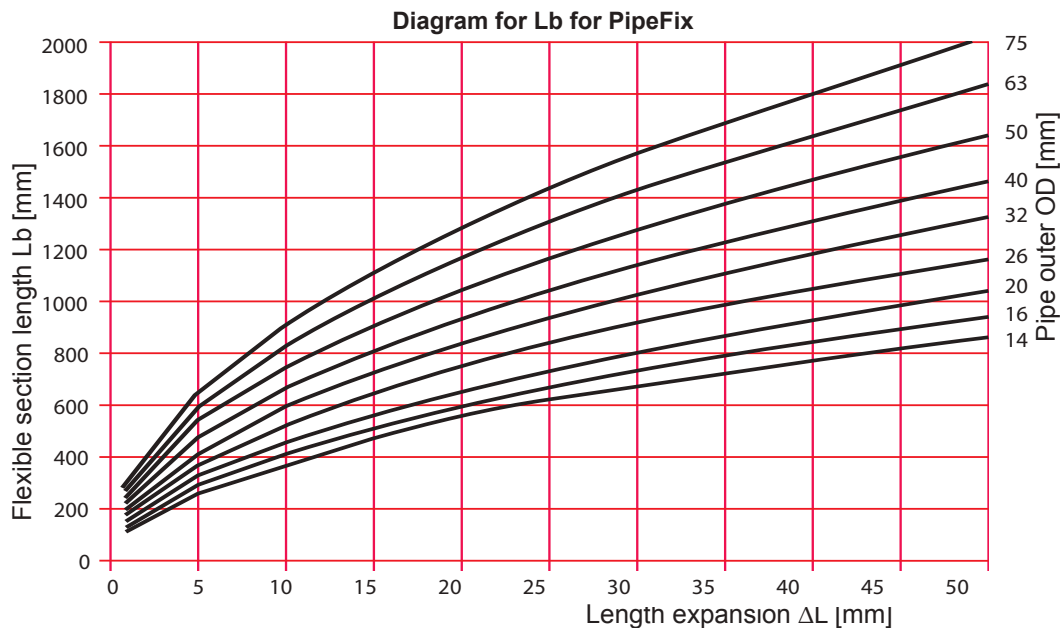

Junction

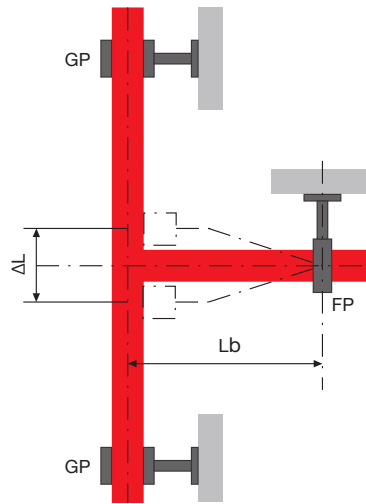

- FP clamp where pipe is fixed
- GP clamp where pipe can move
- Lb length for bending [mm]
- ΔL change of length of pipe [mm]

The calculation of Lb is given in the section above.
 This assembly situation occurs, when you have a riser for several levels and junctions to each floor.
 You can solve this problem in two ways.

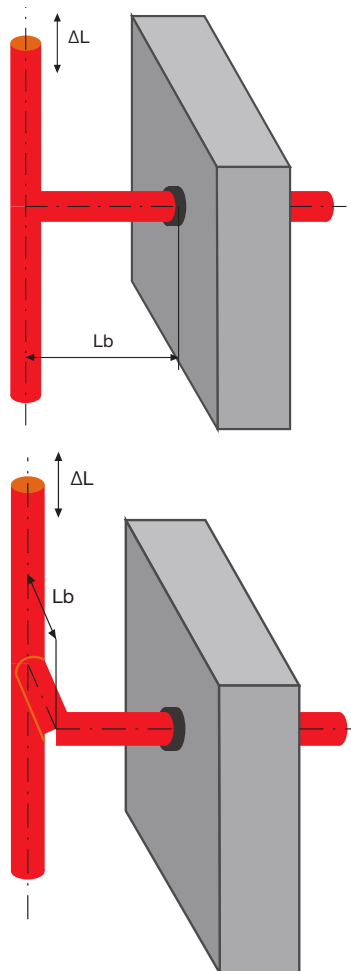

☑ Straight installation

Expansion compensation

There are two possibilities to compensate the change of length between two fixed clamps. U-expansion bend or Z-expansion bend.

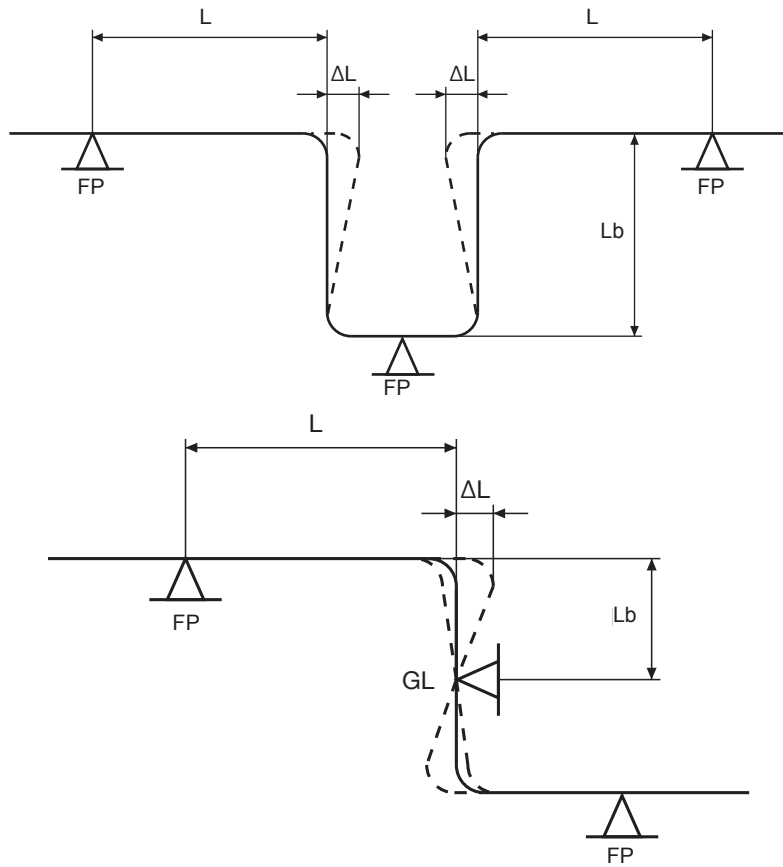

More common is the U-expansion bend.

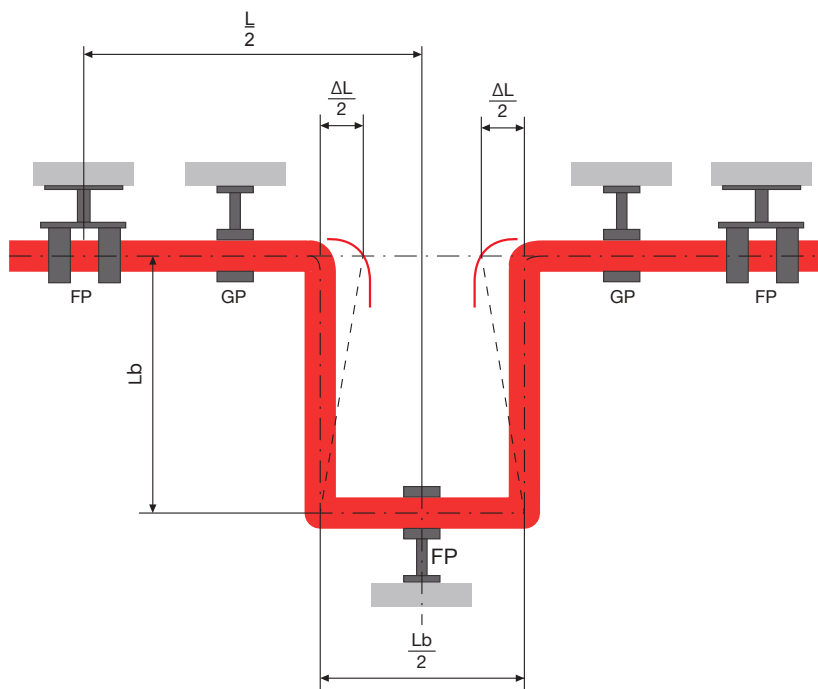

The drawing above shows clearly, how a U-expansion bend works.

You have a length L from the left to the right fixed clamp.
 Therefore you can calculate ΔL .
 Because you have two angles, each of them has to compensate $\Delta L/2$.
 For $\Delta L/2$ you can calculate L_b .
 The width of the U-expansion bend has to be $L_b/2$.

Where to make a U-expansion bend

Pipes for cold water, insulated

If the difference between installation temperature and medium temperature is less than 10 K, the expansion will be very low. Therefore up to a length of 100 m no U-expansion bend is needed.

The pipe has to be insulated, so that it is guaranteed that the pipe doesn't become warmer because of external influences (space heating, a near warm water pipe, ...).

If there is a junction or an angle, please ensure that the flexible section length L_b to the first clamp is observed.

Pipes for warm water

Length max. 10 m

Up to a length of 10 m no U-expansion bend is needed.

A fixed clamp has to be installed appr. in the middle.

If there is a junction or an angle, please ensure that the flexible section length L_b to the first clamp is observed.

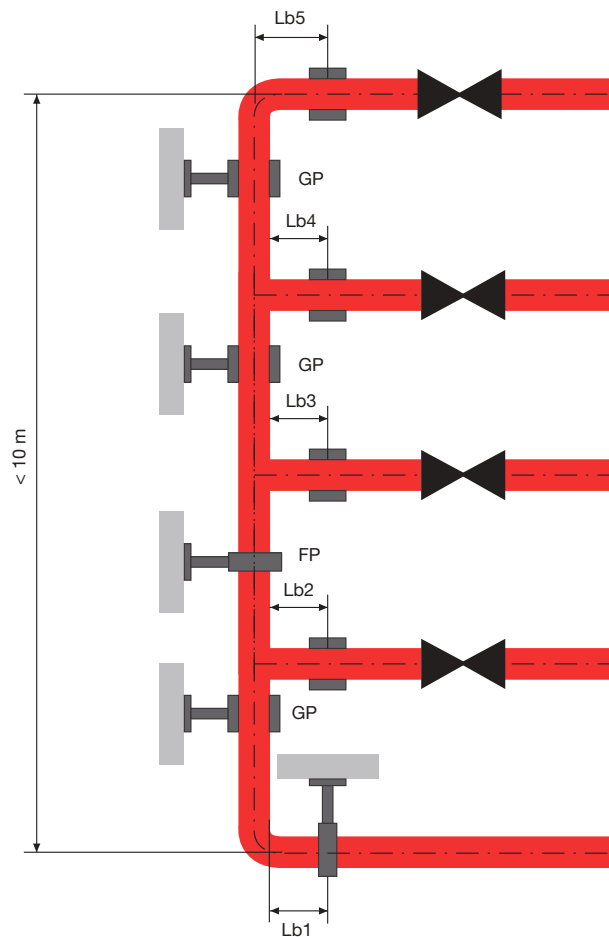

Length > 10 m

Every 10 m a U-expansion bend should be installed.

Fixed clamps are at the U-expansion bend and in the middle between them.

If there is a junction or an angle, please ensure that the flexible section length L_b to the first clamp is observed.

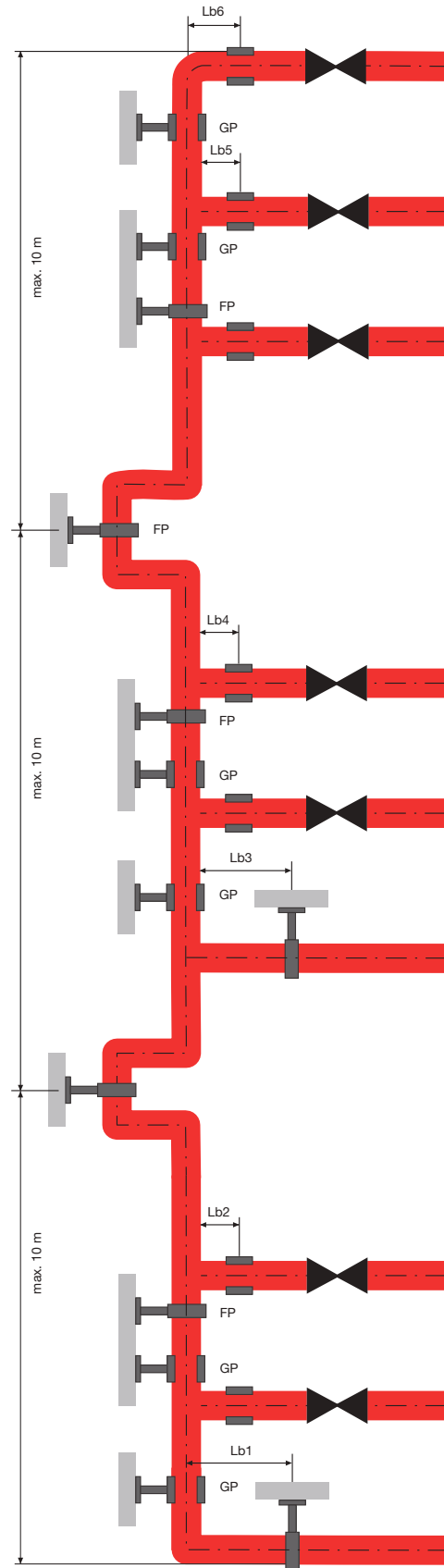

Support intervals

Support intervals for freely suspended systems

The recommended support intervals can be found in the table below.

Plastic or metal pipe clamps should have a soft lining of rubber or another soft material, in order to avoid damage to the pipe and to reduce noise transmission.

Dimension [Ø mm]	Support interval [m]	Dimension [Ø mm]	Support interval [m]
14	0.8	32	1.6
16	0.8	40	1.7
20	1.0	50	1.8
26	1.2	63	2.0

Support intervals for not freely suspended systems

Pipes can be mounted on a concrete ceiling, under plaster or in a pre-wall-installation.

For pipes with Ø14-32 mm support intervals of 0.8 m and for pipes Ø40 mm and bigger support intervals of 1.2 m are recommended.

Support intervals for pipes in protective conduit

If pressure shocks cause movements of the pipes in the protective conduits, unwanted noise can occur. To avoid any unwanted noise, support intervals of 0.6 m are recommended.

For example:

Straight PipeFix-pipe installation with 60 m, Dim 32 mm, temperature difference 60 K

The fixed clamp at the U-expansion bend is not mentioned.

1) Fixed clamp at the beginning and at the end -> 1 U-expansion bend

-> NOT TO BE RECOMMENDED!

L = 60 m

$\Delta L = 82.8 \text{ mm}$ (calculated with $\alpha = 0.023 \text{ mm/mK}$)

$\Delta L/2 = 41.4 \text{ mm}$

Lb around 1200 mm (acc. to the diagram)

Lb/2 around 600 mm

2) Fixed clamp every 20 m -> 3 U-expansion bends

-> NOT TO BE RECOMMENDED!

L = 20 m

$\Delta L = 27.6 \text{ mm}$

$\Delta L/2 = 13.8 \text{ mm}$

Lb around 700 mm

Lb/2 around 350 mm

3) Fixed clamp every 10 m -> 5 U-expansion bends

-> RECOMMENDED!

L = 10 m

$\Delta L = 13.8 \text{ mm}$

$\Delta L/2 = 6.9 \text{ mm}$

Lb around 450 mm

Lb/2 around 225 mm

Please note

The above guidance information is based on theoretical conditions, the installation of fixed points, of gliding points, of U-bends etc, depends on the maximum temperature difference and on the local conditions. All these things have to be observed by the planner and by the installer.

☑ Bending radius

The pipe can be bent using a bending tool such as an inner or outer spring, or the usual bending tools or by hand. The minimum bending radius must always be adhered to. For DN 32 pipes or larger, fittings must always be used.

d Ø	Radius with bending tool [mm]	Radius without bending tool [mm]
10	20	50
14	28	70
16	32	80
18	36	90
20	40	100
26	130	260
32 - 63	HERZ PipeFix elbows	HERZ PipeFix elbows

For a working environment temperature less than +5°C there is an increased risk of the pipe snapping or kinking during bending. For bending pipes under +5°C the relevant part of the pipe must be warmed up.

Pipe bends after a press fitting or clip must have a section of pipe 5 x DN between fitting and bend in order to avoid damage to the pipes. Where there are creases in the piping these sections must always be changed.

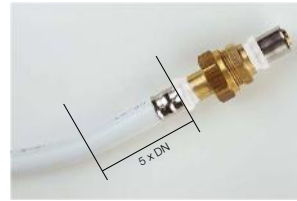
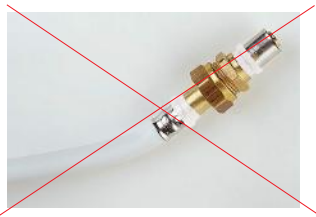

Pipe friction loss diagram

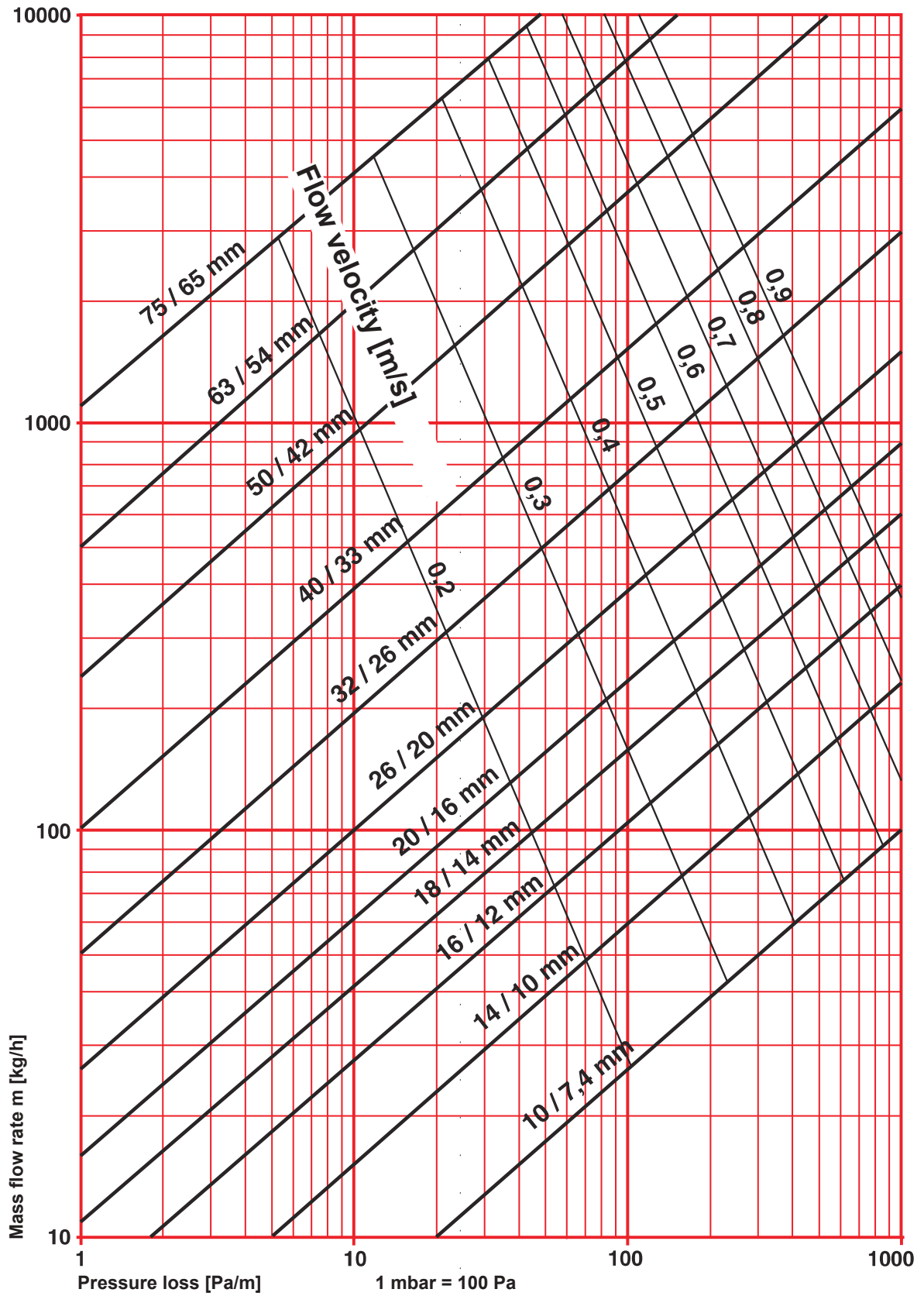

Processing of HERZ pipes with HERZ fittings

The tube is cut to length at right angles with suitable tool. Suitable tools are commercial available pipe shears, pipe cutters and hacksaws.



The pipe is trimmed and calibrated with a special tool suitable for its diameter. The resulting shavings must be removed from the end of the pipe. If the calibrator is fixed in a drilling machine, the maximum revolutions of 10rpm must not be exceeded.



Placing the fitting on the pipe. Check the correct pipe engagement through the vision ports on the press sleeve - the pipe must have fully engaged on the fitting and be visible in the ports.



Complete pressure sealing using a press device or manual press pliers. The pipes must be free of stress. The press procedure is complete if the jaws have been closed completely.

Press tools are precision tools and should be handled accordingly. HERZ PipeFix is pressed using the profile „TH“, so that the usual tools (hand press device, accupress device, etc.) can be used. Small „A“ intervals to the wall or floor are possible.

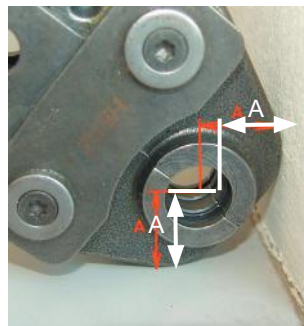

d Ø	A [mm]	d Ø	A [mm]	d Ø	A [mm]
10	25	20	30	40	40
14	25	26	30	50	70
16	25	32	40	63	70







Checking the pressure sealing: On the side of the press sleeves you can see two parallel, ring-shaped grooves with a bulge between them.

Non-detachable connections such as press fittings can be buried after installation (See local or national legislation for confirmation). Press connections are prohibited from being buried in floors in the District heating company of Vienna (Vienna's remote heating programme) area. To avoid corrosion to the fittings there must be galvanic separation from the concrete or masonry using moisture insulation. This insulation can, for example, be carried out using heat shrinking materials or corrosion protection tape. In case, compatibility with the pipe material and fitting must be checked.

PPSU fittings are to be protected against building materials, paints, foams and adhesives containing solvents.

It is imperative that the stated pipe diameter and pipe wall thickness are adhered to when processing.

Connection resistance								
Pipe dim.	Pipe bend	Angles	T-piece flow re-direction one-way (1 into 2) 	T-piece flow mixer (2 into 1) 	T-piece flow re-director two-way (1 into 2) 	T-piece flow collection (2 into 1) 	Passage piece	wall angles
Values in equivalent pipe lengths in m								
14	0,70	1,50	1,30	1,60	1,70	1,70	1,00	1,40
16	0,60	1,40	1,20	1,50	1,60	1,60	0,90	1,30
18	0,55	1,20	0,90	1,40	1,50	1,50	0,70	1,20
20	0,50	1,10	0,60	1,30	1,40	1,40	0,50	1,10
26	0,40	1,00	0,50	1,20	1,30	1,30	0,40	-
32	0,30	0,80	0,30	1,00	1,10	1,10	0,30	-
40	0,26	0,76	0,28	0,95	1,00	1,00	0,26	-
50	0,22	0,72	0,26	0,90	0,95	0,95	0,22	-
63	0,18	0,70	0,24	0,85	0,90	0,90	0,18	-

To simplify the pipe network calculation the resistance values of the fittings are given in equivalent pipe lengths. These pipe lengths are to be found in the above table and are added to the length of the pipe network when calculating the pipe network.

$$\Delta p_g = R \times l + Z + \Delta p_v$$

Δp_g ...	Total pressure loss in the heating circuit
R ...	Pressure loss per running m of pipe [Pa/m]
l ...	Pipe length in meter
Z ...	Sum of the individual resistances
Δp_v ...	Pressure loss of the heating circuit thermostatic valves

Fittings

Technical specification

Maximal operation temperature	70 °C - 90 °C depending on the application class
Maximal operation temperature (max. 1 year)	95 °C
Emergency operation temperature (max. 100 h)	100 °C
Maximal operation pressure	8 - 10 bar depending on the dimension
Maximal operation pressure (max. 1 year)	12 bar
Min. temperature, °C	-20 °C (when mounting: 0 °C; with special precautions -10 °C)
Operating time	50 years (@ T ≤ 70 °C)

- Press contour: TH, machine manufacturer: REMS (in the delivery program)
- Axial force pressing machine: standard: 34 kN, mini tools: 24 kN
- Material fitting: drinking water acc. to UBA-list and 4MS-list or PPSU (green ring), heating CW602N (white ring)
- Material compression sleeve: stainless steel.

Certificates

- ÖNORM EN ISO 21003
- ÖVGW W 1.379
- DVGW DW - 8501BN0454
- ÜA - sign
 - Press fittings made of metal: R-15.2.3-20-17038, WIEN-ZERT
 - Press fittings made of PPSU: R-15.2.1-20-17037, WIEN-ZERT

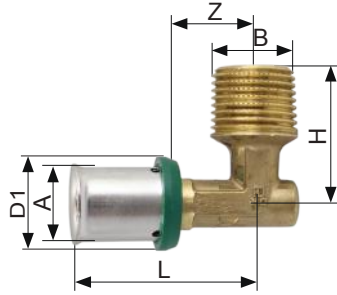
HERZ Angle with external thread

Bestellnummer	A, mm	B, "	L, mm	H, mm	D, mm	Z, mm
T 7116 11	16 x 2	R 1/2	44	34	23	20
T 7120 11	20 x 2	R 1/2	50	34	27	20
T 7120 12	20 x 2	R 3/4	52	45	27	20
T 7126 12	26 x 3	R 3/4	56	45	33	32
T 7132 13	32 x 3	R 1	55	49	39	23
T 7140 14	40 x 3,5	R 1¼	55	55	47	23
T 7150 14	50 x 4	R 1¼	76	63	57	40
T 7163 16	63 x 4,5	R 2	83	70	70	47

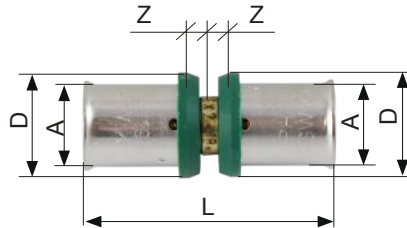
HERZ Coupling

Order number	A, mm	L, mm	D, mm	Z, mm
T 7016 00	16 x 2	58	23	5
T 7020 00	20 x 2	58	27	5
T 7026 00	26 x 3	65	33	9
T 7032 00	32 x 3	65	39	9
T 7040 00	40 x 3,5	65	47	9
T 7050 00	50 x 4	97	57	13
T 7063 00	63 x 4,5	98	70	13
T 7075 00	75 x 5	106	82	7

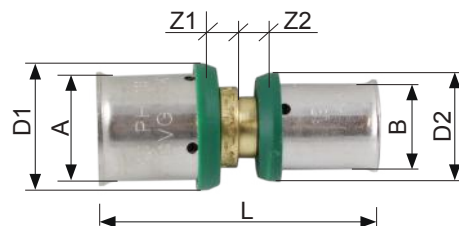
HERZ Coupling, Reduced Coupling

Order number	A, mm	B, mm	L, mm	D1, mm	D2, mm	Z1, mm	Z2, mm
T 7020 01	20 x 2	16 x 2	62	27	23	7	7
T 7026 01	26 x 3	16 x 2	65	33	23	9	9
T 7026 02	26 x 3	20 x 2	65	33	27	9	9
T 7032 01	32 x 3	16 x 2	65	39	23	9	9
T 7032 02	32 x 3	20 x 2	65	39	27	9	9
T 7032 06	32 x 3	26 x 3	65	39	33	9	9
T 7040 02	40 x 3,5	26 x 3	65	47	33	9	9
T 7040 03	40 x 3,5	32 x 3	65	47	39	9	9

Order number	A, mm	B, mm	L, mm	D1, mm	D2, mm	Z1, mm	Z2, mm
T 7050 01	50 x 4	26 x 3	81	57	33	13	9
T 7050 02	50 x 4	32 x 3	81	57	39	13	9
T 7050 03	50 x 4	40 x 3,5	81	57	47	13	9
T 7063 01	63 x 4,5	26 x 3	82	70	33	13	9
T 7063 02	63 x 4,5	32 x 3	82	70	39	13	9
T 7063 03	63 x 4,5	40 x 3,5	82	70	47	13	9
T 7063 04	63 x 4,5	50 x 4	98	70	57	13	13
T 7075 02	75 x 5	50 x 4	102	82	57	7	13
T 7075 01	75 x 5	63 x 4,5	102	82	70	7	13

HERZ Press fitting end cap

Order number	A, mm	L, mm	D, mm	Z, mm
T 7016 10	16 x 2	31	23	7
T 7020 10	20 x 2	31	27	7
T 7026 10	26 x 3	33	33	9
T 7032 10	32 x 3	33	39	9
T 7040 10	40 x 3,5	33	47	9
T 7050 10	50 x 4	49	57	13
T 7063 10	63 x 4,5	49	70	13

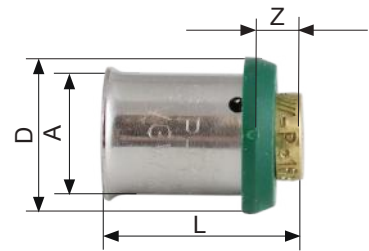

HERZ Angle with internal thread

Order number	A, mm	B, in	L, mm	H, mm	D, mm	Z, mm
T 7116 21	16 x 2	Rp 1/2	44	34	23	20
T 7120 21	20 x 2	Rp 1/2	50	34	27	20
T 7120 22	20 x 2	Rp 3/4	52	45	27	28
T 7126 22	26 x 3	Rp 3/4	56	45	33	32
T 7132 23	32 x 3	Rp 1	55	49	39	31
T 7140 24	40 x 3,5	Rp 1 1/4	55	55	47	31
T 7150 24	50 x 4	Rp 1 1/4	76	63	57	40
T 7150 25	50 x 4	Rp 1 1/2	76	63	57	40
T 7163 26	63 x 4,5	Rp 2	83	70	70	47

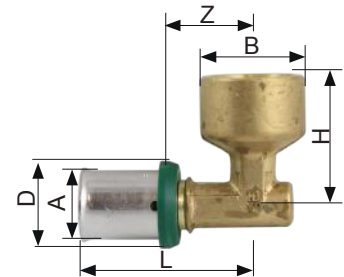

HERZ T-piece

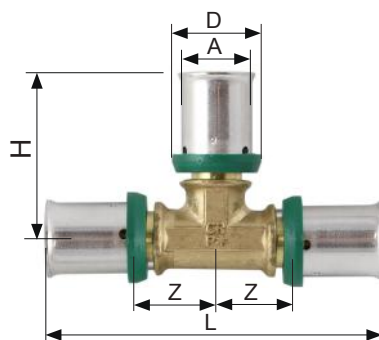

Order number	A, mm	L, mm	H, mm	D, mm	Z, mm
T 7216 00	16 x 2	83	42	23	18
T 7220 00	20 x 2	83	42	27	18
T 7226 00	26 x 3	102	51	33	27
T 7232 00	32 x 3	106	53	39	29
T 7240 00	40 x 3,5	110	55	47	31
T 7250 00	50 x 4	152	76	57	40
T 7263 00	63 x 4,5	166	83	70	47
T 7275 00	75 x 5	198	99	83	53

HERZ T-piece, reduced

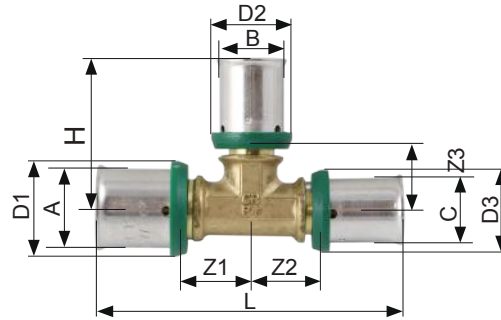

Order number	A, mm	B, mm	C, mm	L, mm	H, mm	D1, mm	D2, mm	D3, mm	Z1, mm	Z2, mm	Z3, mm
T 7216 03	16 x 2	20 x 2	16 x 2	83	42	23	27	23	18	18	18
T 7220 03	20 x 2	16 x 2	16 x 2	83	42	27	23	23	18	18	18
T 7220 01	20 x 2	16 x 2	20 x 2	83	42	27	23	27	18	18	18
T 7220 08	20 x 2	20 x 2	16 x 2	83	42	27	27	23	18	18	18
T 7220 06	20 x 2	26 x 3	20 x 2	102	51	27	33	27	27	27	27
T 7226 21	26 x 3	16 x 2	16 x 2	95	48	33	23	23	25	25	25
T 7226 03	26 x 3	16 x 2	26 x 3	97	49	33	23	33	25	25	25
T 7226 13	26 x 3	20 x 2	16 x 2	102	51	33	27	23	27	27	27
T 7226 14	26 x 3	20 x 2	20 x 2	102	51	33	27	27	27	27	27
T 7226 05	26 x 3	20 x 2	26 x 3	97	49	33	27	33	25	25	25
T 7226 16	26 x 3	26 x 3	16 x 2	112	56	33	33	23	32	32	32
T 7226 15	26 x 3	26 x 3	20 x 2	112	56	33	33	27	32	32	32
T 7226 17	26 x 3	32 x 3	26 x 3	106	53	33	39	33	29	29	29
T 7232 01	32 x 3	16 x 2	32 x 3	106	53	39	23	39	29	29	29
T 7232 04	32 x 3	20 x 2	32 x 3	106	53	39	27	39	29	29	29
T 7232 11	32 x 3	20 x 2	26 x 3	106	53	39	27	33	29	29	29
T 7232 09	32 x 3	26 x 3	26 x 3	106	53	39	33	33	29	29	29
T 7232 07	32 x 3	26 x 3	32 x 3	106	53	39	33	39	29	29	29
T 7232 15	32 x 3	32 x 3	20 x 2	106	53	39	39	27	29	29	29
T 7232 14	32 x 3	32 x 3	26 x 3	106	53	39	39	33	29	29	29
T 7232 10	32 x 3	40 x 3,5	32 x 3	106	53	39	47	39	29	29	29
T 7240 06	40 x 3,5	26 x 3	32 x 3	110	55	47	33	37	31	31	31
T 7240 02	40 x 3,5	26 x 3	40 x 3,5	110	55	47	33	47	31	31	31
T 7240 04	40 x 3,5	32 x 3	32 x 3	110	50	47	39	39	31	31	26
T 7240 03	40 x 3,5	32 x 3	40 x 3,5	110	55	47	39	47	31	31	31
T 7240 07	40 x 3,5	40 x 3,5	26 x 3	110	55	47	47	33	31	31	31
T 7240 08	40 x 3,5	40 x 3,5	32 x 3	110	55	47	47	39	31	31	31
T 7240 12	40 x 3,5	50 x 4	40 x 3,5	140	78	47	57	47	47	47	47
T 7250 03	50 x 4	26 x 3	50 x 4	152	62	57	33	57	40	40	38
T 7250 06	50 x 4	32 x 3	40 x 3,5	152	62	57	39	47	46	46	38
T 7250 01	50 x 4	32 x 3	50 x 4	152	62	57	37	57	40	40	38
T 7250 05	50 x 4	40 x 3,5	40 x 3,5	137	61	57	47	47	39	39	37
T 7250 02	50 x 4	40 x 3,5	50 x 4	152	59	57	47	57	40	40	35
T 7250 07	50 x 4	50 x 4	32 x 3	152	76	57	57	39	46	46	40
T 7250 08	50 x 4	50 x 4	40 x 3,5	152	76	57	57	47	46	46	40
T 7263 03	63 x 4,5	32 x 3	63 x 4,5	166	67	70	37	70	47	47	43
T 7263 04	63 x 4,5	40 x 3,5	50 x 4	166	67	70	47	57	47	47	43
T 7263 01	63 x 4,5	40 x 3,5	63 x 4,5	153	67	70	47	70	40	40	43
T 7263 05	63 x 4,5	50 x 4	50 x 4	166	83	70	57	57	47	47	47
T 7263 02	63 x 4,5	50 x 4	63 x 4,5	166	83	70	57	70	47	47	47
T 7263 06	63 x 4,5	63 x 4,5	40 x 3,5	150	83	70	70	47	45	45	47
T 7263 07	63 x 4,5	63 x 4,5	50 x 4	166	83	70	70	57	47	47	47
T 7263 07	63 x 4,5	63 x 4,5	50 x 4	166	83	70	70	57	47	47	47

HERZ T-piece with external thread

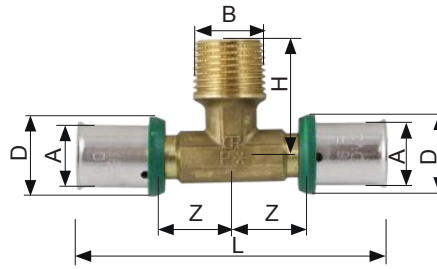

Bestellnummer	A, mm	B, "	L, mm	H, mm	D, mm	Z, mm
T 7216 51	16 x 2	R 1/2	90	34	23	21
T 7220 51	20 x 2	R 1/2	91	34	27	22
T 7220 52	20 x 2	R 3/4	98	34	27	25
T 7226 51	26 x 3	R 1/2	112	38	33	32
T 7226 52	26 x 3	R 3/4	112	38	33	32
T 7226 53	26 x 3	R 1	112	43	33	32
T 7232 51	32 x 3	R 3/4	110	47	39	31
T 7232 52	32 x 3	R 1	110	47	39	31
T 7240 52	40 x 3,5	R 1	110	55	47	31
T 7240 53	40 x 3,5	R 1¼	110	55	47	31
T 7250 53	50 x 4	R 1¼	152	61	57	40
T 7250 54	50 x 4	R 1½	152	61	57	40
T 7263 55	63 x 4,5	R 2	166	70	70	47

HERZ T-piece with internal thread

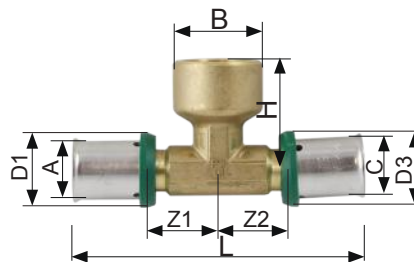

Order number	A, mm	B, in	C, mm	L, mm	H, mm	D1, mm	D3, mm	Z1, mm	Z2, mm
T 7216 41	16 x 2	Rp 1/2	16 x 2	90	34	23	23	21	21
T 7220 41	20 x 2	Rp 1/2	20 x 2	91	34	27	27	22	22
T 7220 42	20 x 2	Rp 3/4	20 x 2	112	43	27	27	32	32
T 7226 42	26 x 3	Rp 1/2	20 x 2	112	38	33	27	32	32
T 7226 41	26 x 3	Rp 1/2	26 x 3	112	37	33	33	32	32
T 7226 44	26 x 3	Rp 3/4	26 x 3	112	43	33	33	32	32
T 7232 43	32 x 3	Rp 1/2	32 x 3	110	47	39	39	31	31
T 7232 41	32 x 3	Rp 3/4	32 x 3	110	47	39	39	31	31
T 7232 42	32 x 3	Rp 1	32 x 3	110	47	39	39	31	31
T 7232 44	32 x 3	Rp 1¼	32 x 3	125	55	39	39	39	39
T 7240 41	40 x 3,5	Rp 1	40 x 3,5	110	55	47	47	31	31
T 7240 42	40 x 3,5	Rp 1¼	40 x 3,5	110	55	47	47	31	31
T 7250 42	50 x 4	Rp 1¼	50 x 4	152	63	57	57	40	40
T 7250 43	50 x 4	Rp 1½	50 x 4	152	63	57	57	40	40
T 7263 44	63 x 4,5	Rp 2	63 x 4,5	166	70	70	70	47	47

HERZ 90° angle

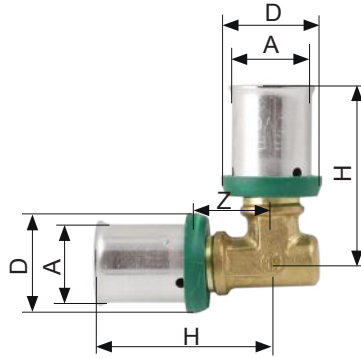

Order number	A, mm	L, mm	H, mm	D, mm	Z, mm
T 7116 00	16 x 2	39	39	23	15
T 7120 00	20 x 2	42	42	27	18
T 7126 00	26 x 3	51	51	33	27
T 7132 00	32 x 3	55	55	39	31
T 7140 00	40 x 3,5	58	58	47	34
T 7150 00	50 x 4	76	76	57	40
T 7163 00	63 x 4,5	83	83	70	47
T 7175 00	75 x 5	99	99	83	53

Angle 45°

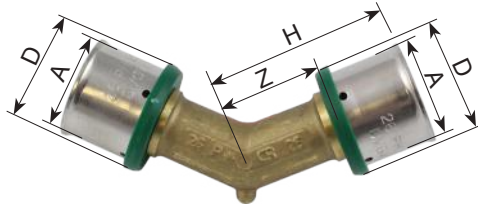

Order number	A, mm	H, mm	D, mm	Z, mm
T 7126 01	26 x 3	54	33	30
T 7132 01	32 x 3	56	39	32
T 7140 01	40 x 3,5	56	47	32
T 7150 01	50 x 4	78	57	35
T 7163 01	63 x 4,5	85	70	41

Wall angle long

Order number	A, mm	D, mm	B, in	L, mm	H1, mm	H2, mm	Z, mm
T 7116 41	16 x 2	23	Rp 1/2	45	61	78	21
T 7120 41	20 x 2	27	Rp 1/2	45	61	78	21

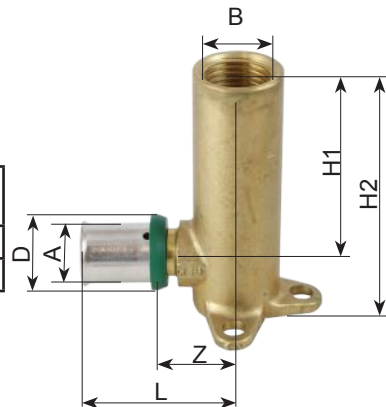

Junction press fitting screw connection, flat-sealing

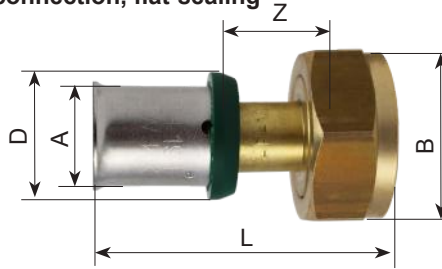

Order number	A, mm	B, in	L, mm	D, mm	Z, mm
T 7016 41	16 x 2	G 3/4	42	23	19
T 7016 42	16 x 2	G 1	35	23	12
T 7020 41	20 x 2	G 3/4	42	27	19
T 7020 42	20 x 2	G 1	35	27	12
T 7026 41	26 x 3	G 3/4	42	33	19
T 7026 42	26 x 3	G 1	35	33	12
T 7026 43	26 x 3	G 1 1/4	35	33	12
T 7032 42	32 x 3	G 1	46	35	23
T 7032 43	32 x 3	G 1 1/4	35	39	12
T 7032 44	32 x 3	G 1 1/2	36	39	14
T 7040 44	40 x 3,5	G 1 1/2	47	47	24
T 7040 43	40 x 3,5	G 1 1/4	43	47	21
T 7040 45	40 x 3,5	G 2	38	47	15
T 7050 44	50 x 4	G 1 1/2	75	57	32
T 7050 45	50 x 4	G 2	75	57	32

Screw connection with cone, nickel-plated

Order number	A, mm	B, in	L, mm	D, mm	Z, mm
P 7016 86	16 x 2	M 22 x 1,5	47	23	25
P 7016 90	16 x 2	G 1/2	47	23	25
P 7016 82	16 x 2	G 3/4	47	23	25
P 7020 90	20 x 2	G 1/2	50	27	27
P 7020 82	20 x 2	G 3/4	50	27	27

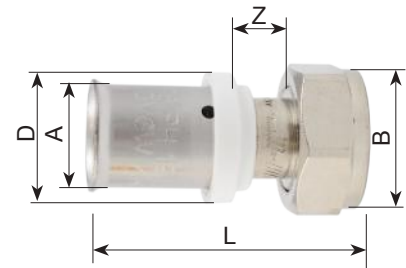

Screw connection with cone, unfinished

Order number	A, mm	B, in	L, mm	D1, mm	Z, mm
T 7016 81	16 x 2	G 3/4	50	23	27
T 7020 81	20 x 2	G 3/4	50	27	27

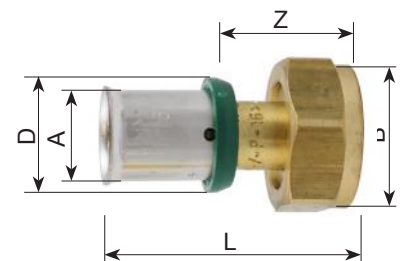

Angle screw connection

Order number	A, mm	B, in	L, mm	H, mm	D, mm	Z, mm
P 7116 14	16 x 2	G 3/4	44	33	23	22
P 7120 14	20 x 2	G 3/4	44	33	27	22

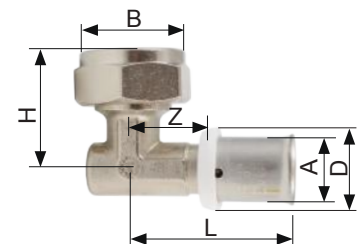

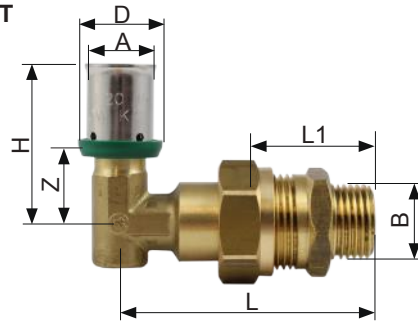
Angle screw connection with MT

Order number	A, mm	B, in	L, mm	H, mm	D, mm	Z, mm	L1, mm
T 7116 71	16 x 2	R 1/2	67	44	23	20	33
T 7120 71	20 x 2	R 1/2	67	46	27	20	33
T 7120 72	20 x 2	R 3/4	67	46	27	20	33
T 7126 73	26 x 3	R 1	79	46	33	27	36
T 7132 74	32 x 3	R 1¼	95	55	39	31	43

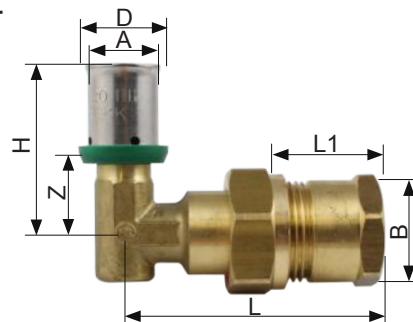
Angle screw connection with FT

Order number	A, mm	B, in	L, mm	H, mm	D, mm	Z, mm	L1, mm
T 7116 81	16 x 2	Rp 3/4	64	44	23	20	30
T 7120 81	20 x 2	Rp 1/2	64	46	27	20	30
T 7120 82	20 x 2	Rp 3/4	64	46	27	20	30
T 7126 83	26 x 3	Rp 1	80	46	33	27	35
T 7132 84	32 x 3	Rp 1¼	95	55	39	31	43

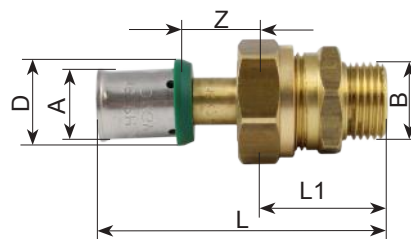
Press fitting screw connection with MT flat-sealing

Order number	A, mm	B, in	L, mm	D, mm	Z, mm	L1, mm
T 7016 61	16 x 2	R 1/2	75	23	12	33
T 7016 62	16 x 2	R 3/4	61	23	19	33
T 7020 61	20 x 2	R 1/2	75	27	12	33
T 7020 62	20 x 2	R 3/4	61	27	19	33
T 7026 62	26 x 3	R 3/4	61	33	19	33
T 7026 63	26 x 3	R 1	71	33	35	36
T 7032 63	32 x 3	R 1	71	39	35	36
T 7040 64	40 x 3,5	R 1¼	86	47	43	43
T 7050 65	50 x 4	R 1½	119	57	75	44
T 7063 66	63 x 4,5	R 2	119	70	75	44

Press fitting screw connection with FT, flat-sealing

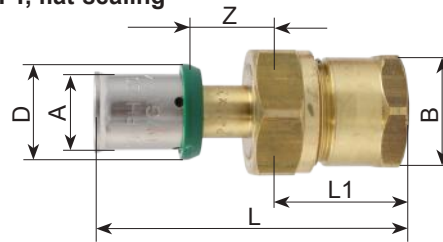

Order number	A, mm	B, in	L, mm	L1, mm	D1, mm	Z, mm
T 7016 71	16 x 2	Rp 1/2	72	30	23	19
T 7016 72	16 x 2	Rp 3/4	72	30	23	19
T 7020 71	20 x 2	Rp 1/2	72	30	27	19
T 7020 72	20 x 2	Rp 3/4	72	30	27	19
T 7026 72	26 x 3	Rp 3/4	72	30	33	19
T 7026 73	26 x 3	Rp 1	70	35	33	12
T 7032 73	32 x 3	Rp 1	70	35	39	12
T 7040 74	40 x 3,5	Rp 1¼	86	43	47	21
T 7050 75	50 x 4	Rp 1½	120	45	57	32
T 7063 76	63 x 4,5	Rp 2	121	45	70	32

Press fitting screw connection coupling, flatsealing

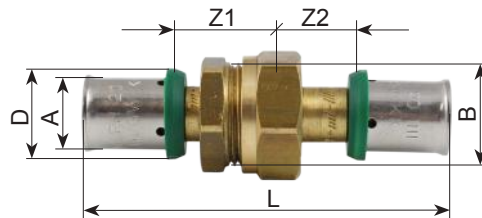

Order number	A, mm	B, in	L, mm	D, mm	Z1, mm	Z2, mm
T 7016 51	16 x 2	G 3/4	90	23	27	19
T 7020 51	20 x 2	G 3/4	90	27	27	19
T 7026 52	26 x 3	G 1	85	33	27	12
T 7032 53	32 x 3	G 1¼	85	39	27	12
T 7040 53	40 x 3,5	G 1¼	93	47	27	21
T 7050 55	50 x 4	G 2	157	57	36	32

Junction with male thread

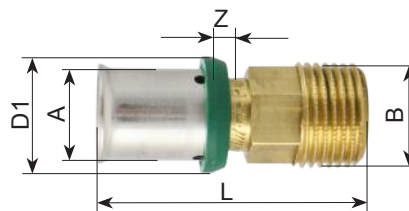

Order number	A, mm	B, in	L, mm	D1, mm	Z, mm
T 7016 11	16 x 2	R 1/2	54	23	5
T 7016 12	16 x 2	R 3/4	54	23	5
T 7020 11	20 x 2	R 1/2	54	27	5
T 7020 12	20 x 2	R 3/4	54	27	5
T 7026 12	26 x 3	R 3/4	54	33	5
T 7026 13	26 x 3	R 1	54	33	5
T 7032 13	32 x 3	R 1	54	39	5
T 7032 14	32 x 3	R 1¼	54	39	5
T 7040 13	40 x 3,5	R 1	59	47	5
T 7040 14	40 x 3.5	R 1¼	59	47	5
T 7050 14	50 x 4	R 1¼	83	57	12

Order number	A, mm	B, in	L, mm	D1, mm	Z, mm
T 7050 15	50 x 4	R 1½	83	57	12
T 7063 16	63 x 4.5	R 2	92	70	12
T 7075 16	75 x 5	R 2	96	83	12
T 7075 18	75 x 5	R 2½	96	83	12

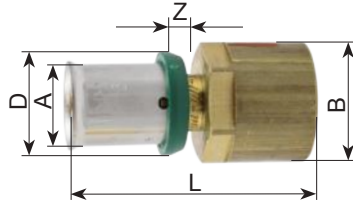
Junction with female thread

Order number	A, mm	B, in	L, mm	D, mm	Z, mm
T 7016 21	16 x 2	Rp 1/2	53	23	5
T 7020 21	20 x 2	Rp 1/2	53	27	5
T 7020 22	20 x 2	Rp 3/4	55	27	5
T 7026 22	26 x 3	Rp 3/4	55	33	5
T 7026 23	26 x 3	Rp 1	56	33	5
T 7032 23	32 x 3	Rp 1	56	39	5
T 7032 24	32 x 3	Rp 1¼	64	39	5
T 7040 23	40 x 3,5	Rp 1	56	47	7
T 7040 24	40 x 3.5	Rp 1¼	64	47	7
T 7050 24	50 x 4	Rp 1¼	76	57	12
T 7050 25	50 x 4	Rp 1½	76	57	12
T 7063 26	63 x 4,5	Rp 2	92	70	12

Non-crossing T-piece

Order number	H, mm	h, mm	B, in	L, mm	l, mm
P 7200 31	99	50	Rp 1/2	120	50

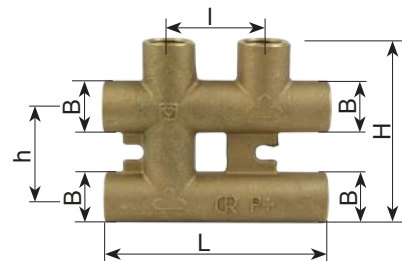
Box for non-crossing T-piece FT 1/2 (plastic)

Order number	A, mm	B, mm	H, mm
P 1020 21	120	120	60

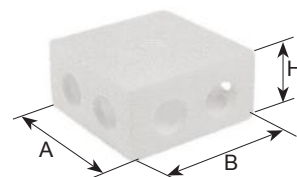

Screw-in part R 1/2, O-ring sealing, for non-crossing T-piece

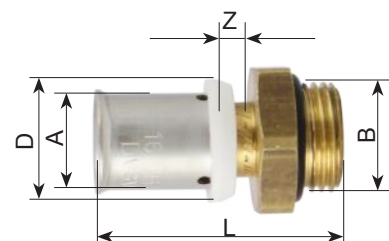
Order number	A, mm	B, in	L, mm	D, mm	Z, mm
P 7016 18	16 x 2	G 1/2	46	23	5
P 7020 18	20 x 2	G 1/2	46	27	5
P 7026 18	26 x 3	G 1/2	46	33	5

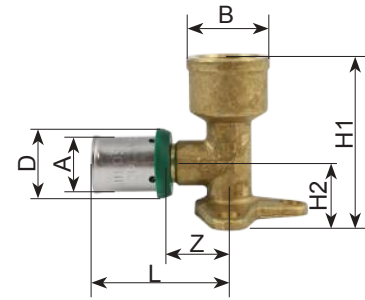

Wall angle short

Order number	A, mm	D1, mm	B, in	L, mm	H1, mm	H2, mm	Z, mm
T 7116 31	16 x 2	23	Rp 1/2	44	52	17	22
T 7120 31	20 x 2	27	Rp 1/2	44	52	17	22
T 7120 32	20 x 2	27	Rp 3/4	50	53	21	28
T 7126 32	26 x 3	33	Rp 3/4	50	53	21	28



Flush cistern T-piece

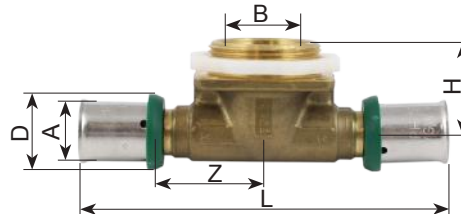

Order number	A, mm	B, in	L, mm	H, mm	D, mm	Z1, mm
T 7216 61	16 x 2	Rp 1/2	120	28	23	32
T 7220 61	20 x 2	Rp 1/2	120	28	27	32

Flush cistern angle

Order number	A, mm	B, in	L, mm	H, mm	D, mm	Z, mm
T 7116 61	16 x 2	Rp 1/2	55	28	23	20
T 7120 61	20 x 2	Rp 1/2	55	28	27	20

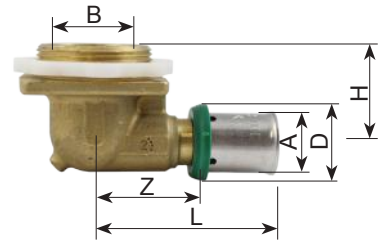

Wall bushing angle

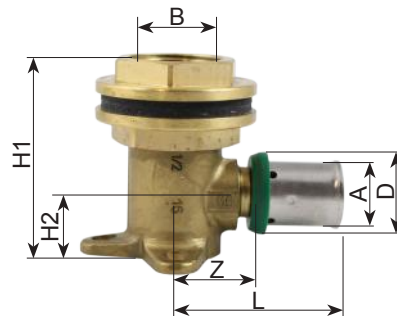

Order number	A, mm	D, mm	B, in	L, mm	H1, mm	H2, mm	Z, mm
T 7116 51	16 x 2	23	Rp 1/2	46	52	18	25
T 7116 52	16 x 2	23	Rp 1/2	46	78	17	25
T 7120 52	20 x 2	27	Rp 1/2	46	78	17	25

Wall angle double U

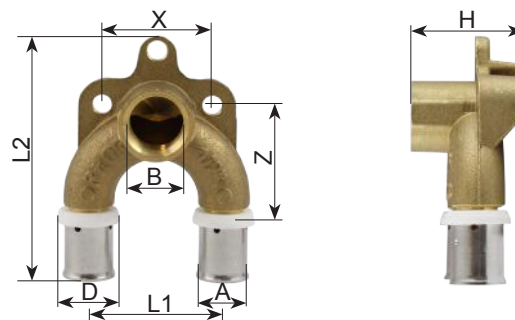

Order number	A, mm	B, in	D, mm	L1, mm	L2, mm	Z, mm	H, mm	X, mm
P 7116 36	16 x 2,0	Rp 1/2	23	50	82	34	39	40
P 7120 36	20 x 2,0	Rp 1/2	27	50	82	34	39	40

Copper radiator connection, nickel-plated, elbow

Order number	A, mm	D, mm	Z, mm	B, mm	H, mm	L, mm
P 7216 91	16x2	23	68	15	300	90
P 7216 92	16x2	23	68	15	1100	90
P 7220 91	20x2	27	68	15	300	90
P 7220 92	20x2	27	68	15	1100	90

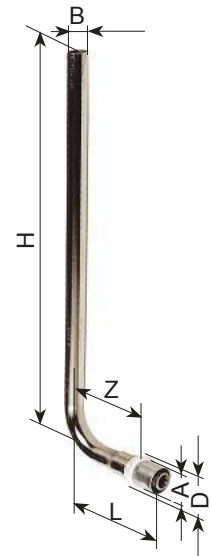
Copper radiator connection, nickel-plated, T-pieces

Order number	A, mm	D, mm	Z, mm	B, mm	H, mm	h, mm	L, mm	l, mm
P 7116 91	16x2	23	39	15	300	50	82	20
P 7116 92	16x2	23	39	15	1100	50	82	20
P 7120 91	20x2	27	39	15	300	50	82	20
P 7120 92	20x2	27	39	15	1100	50	82	20

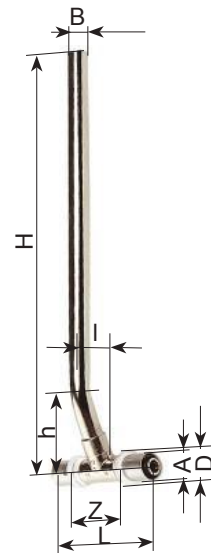

 Calibration tools

Calibration tools for HERZ-pipe, with lever, or using with cordless screwdriver.

Pipe Ø	Calibration tool with lever	Calibration tool for cordless screwdriver	Pipe Ø	Calibration tool with lever	Calibration tool for cordless screwdriver
10 x 1,3	3 F010 11	-	40 x 3,5	P 2011 80	P 2010 80
16 x 2	P 2011 74	P 2010 74	50 x 4	P 2011 83	P 2010 83
20 x 2	P 2011 76	P 2010 76	63 x 4,5	P 2011 87	P 2010 87
26 x 3	P 2011 78	P 2010 78	75 x 5	P 2010 91	
32 x 3	P 2011 79	P 2010 79			

Pressfittings PPSU

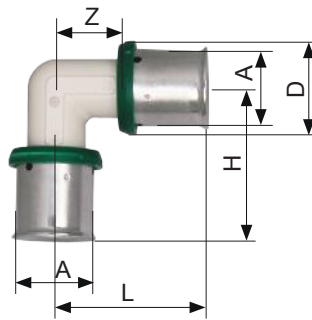
90° angle



Order number	A, mm	L, mm	H, mm	D, mm	Z, mm
R 6116 00	16 x 2	40	40	23	17
R 6120 00	20 x 2	43	43	27	20
R 6126 00	26 x 3	47	47	33	24

T-piece

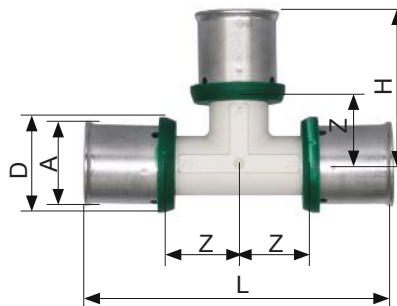

Order number	A, mm	L, mm	H, mm	D, mm	Z, mm
R 6216 00	16 x 2	80	40	23	17
R 6220 00	20 x 2	86	43	27	20
R 6226 00	26 x 3	94	47	33	24

T-piece, middle branch reduced

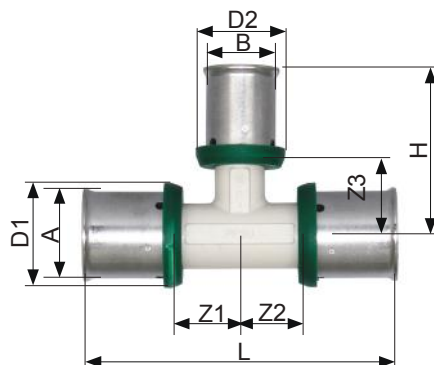

Order number	A, mm	B, mm	C, mm	L, mm	H, mm	D1, mm	D2, mm	Z1, mm	Z2, mm	Z3, mm
R 6220 01	20 x 2	16 x 2	20 x 2	80	43	27	23	17	17	43
R 6226 03	26 x 3	16 x 2	26 x 3	86	47	33	23	17	12	47
R 6226 05	26 x 3	20 x 2	26 x 3	94	47	33	27	20	20	47

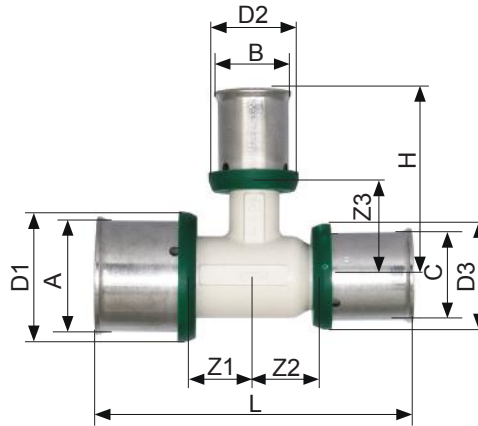
T-piece, expanded/reduced

Order number	A, mm	B, mm	C, mm	L, mm	H, mm	D1, mm	D2, mm	D3, mm	Z1, mm	Z2, mm	Z3, mm
R 6216 03	16 x 2	20 x 2	16 x 2	86	40	23	27	23	20	20	17
R 6220 03	20 x 2	16 x 2	16 x 2	80	43	27	23	23	17	17	20
R 6220 08	20 x 2	20 x 2	16 x 2	86	43	27	27	23	20	20	20
R 6220 06	20 x 2	26 x 3	20 x 2	94	43	27	33	27	24	24	20
R 6226 11	26 x 3	16 x 2	20 x 2	80	47	33	23	27	17	17	24
R 6226 13	26 x 3	20 x 2	16 x 2	86	47	33	27	23	20	20	24
R 6226 14	26 x 3	20 x 2	20 x 2	86	47	33	27	27	20	20	24
R 6226 16	26 x 3	26 x 3	16 x 2	94	47	33	33	23	24	24	24
R 6226 15	26 x 3	26 x 3	20 x 2	94	47	33	33	27	24	24	24

Coupling

Order number	A, mm	L, mm	D1, mm	Z1, mm	Z2, mm
R 6016 00	16 x 2	54	23	4	4
R 6020 00	20 x 2	54	27	4	4
R 6026 00	26 x 3	54	33	4	4

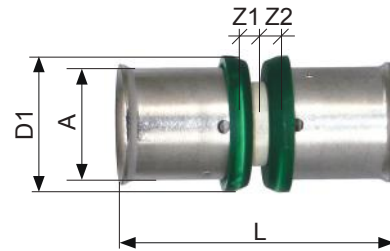
Reduction

Order number	A, mm	B, mm	L, mm	D1, mm	D2, mm	Z1, mm	Z2, mm
R 6020 01	20 x 2	16 x 2	54	27	23	4	4
R 6026 01	26 x 3	16 x 2	54	33	23	4	4
R 6026 02	26 x 3	20 x 2	54	33	27	4	4

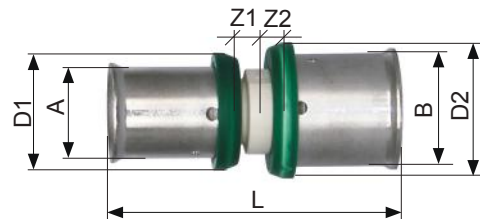
 Recommended maximum flow rates according to DIN EN 806-3

Collective feed lines, risers, floor lines	max. 2.0 m / s
Single lines	max. 4.0 m / s

Note

National regulations may require lower flow rates to avoid pressure surges and noise.

Pressure loss table for HERZ-composite pipe PE-RT/Al/PE-RT

w	16 x 2 mm				20 x 2 mm				26 x 3 mm				32 x 3 mm			
	Vs	Vs	Vs	R	Vs	Vs	Vs	R	Vs	Vs	Vs	R	Vs	Vs	Vs	R
m/s	l/s	l/min	l/h	Pa/m	l/s	l/min	l/h	Pa/m	l/s	l/min	l/h	Pa/m	l/s	l/min	l/h	Pa/m
0,10	0,01	0,7	41	22	0,02	1,2	72	13	0,03	1,9	113	8	0,05	3,2	191	9
0,15	0,02	1,0	61	33	0,03	1,8	109	33	0,05	2,8	170	25	0,08	4,8	287	17
0,20	0,02	1,4	81	78	0,04	2,4	145	54	0,06	3,8	226	40	0,11	6,4	382	29
0,25	0,03	1,7	102	114	0,05	3,0	181	78	0,08	4,7	283	59	0,13	8,0	478	42
0,30	0,03	2,0	122	156	0,06	3,6	217	107	0,09	5,7	339	80	0,16	9,6	573	57
0,35	0,04	2,4	143	202	0,07	4,2	253	140	0,11	6,6	396	105	0,19	11,1	669	75
0,40	0,05	2,7	163	255	0,08	4,8	290	176	0,13	7,5	452	132	0,21	12,7	765	95
0,45	0,05	3,1	183	312	0,09	5,4	326	216	0,14	8,5	509	162	0,24	14,3	860	116
0,50	0,06	3,4	204	374	0,10	6,0	362	259	0,16	9,4	565	195	0,27	15,9	956	140
0,55	0,06	3,7	224	441	0,11	6,6	398	305	0,17	10,4	622	230	0,29	17,5	1051	165
0,60	0,07	4,1	244	513	0,12	7,2	434	355	0,19	11,3	679	268	0,32	19,1	1147	193
0,65	0,07	4,4	265	589	0,13	7,8	470	409	0,20	12,3	735	308	0,35	20,7	1242	222
0,70	0,08	4,8	285	670	0,14	8,4	507	465	0,22	13,2	792	351	0,37	22,3	1338	253
0,75	0,08	5,1	305	756	0,15	9,0	543	525	0,24	14,1	848	396	0,40	23,9	1434	285
0,80	0,09	5,4	326	846	0,16	9,7	579	588	0,25	15,1	905	444	0,42	25,5	1529	320
0,85	0,10	5,8	346	940	0,17	10,3	615	654	0,27	16,0	961	494	0,45	27,1	1625	356
0,90	0,10	6,1	366	1039	0,18	10,9	651	723	0,28	17,0	1018	546	0,48	28,7	1720	394
0,95	0,11	6,4	387	1142	0,19	11,5	688	795	0,30	17,9	1074	601	0,50	30,3	1816	433
1,00	0,11	6,8	407	1250	0,20	12,1	724	870	0,31	18,8	1131	658	0,53	31,9	1911	474
1,10	0,12	7,5	448	1477	0,22	13,3	796	1029	0,35	20,7	1244	779	0,58	35,0	2102	562
1,20	0,14	8,1	489	1722	0,24	14,5	869	1200	0,38	22,6	1357	908	0,64	38,2	2294	656
1,30	0,15	8,8	529	1983	0,26	15,7	941	1383	0,41	24,5	1470	1047	0,69	41,4	2485	756
1,40	0,16	9,5	570	2260	0,28	16,9	1013	1577	0,44	26,4	1583	1195	0,74	44,6	2676	863
1,50	0,17	10,2	611	2554	0,30	18,1	1086	1783	0,47	28,3	1696	1351	0,80	47,8	2867	977
1,60	0,18	10,9	651	2863	0,32	19,3	1158	1999	0,50	30,2	1810	1516	0,85	51,0	3058	1096
1,70	0,19	11,5	692	3188	0,34	20,5	1230	2227	0,53	32,0	1923	1689	0,90	54,2	3249	1222
1,80	0,20	12,2	733	3529	0,36	21,7	1303	2466	0,57	33,9	2036	1871	0,96	57,3	3440	1354
1,90	0,21	12,9	774	3886	0,38	22,9	1375	2716	0,60	35,8	2149	2061	1,01	60,5	3632	1492
2,00	0,23	13,6	814	4257	0,40	24,1	1448	2977	0,63	37,7	2262	2259	1,06	63,7	3823	1636
2,10	0,24	14,3	855	4644	0,42	25,3	1520	3249	0,66	39,6	2375	2466	1,11	66,9	4014	1786
2,20	0,25	14,9	896	5047	0,44	26,5	1592	3531	0,69	41,5	2488	2680	1,17	70,1	4205	1942
2,30	0,26	15,6	936	5464	0,46	27,7	1665	3824	0,72	43,4	2601	2903	1,22	73,3	4396	2104
2,40	0,27	16,3	977	5896	0,48	29,0	1737	4127	0,75	45,2	2714	3134	1,27	76,5	4587	2271
2,50	0,28	17,0	1018	6344	0,50	30,2	1810	4441	0,79	47,1	2827	3373	1,33	79,6	4778	2445
2,60	0,29	17,6	1059	6806	0,52	31,4	1882	4766	0,82	49,0	2941	3621	1,38	82,8	4969	2625
2,70	0,31	18,3	1099	7283	0,54	32,6	1954	5101	0,85	50,9	3054	3876	1,43	86,0	5161	2810
2,80	0,32	19,0	1140	7774	0,56	33,8	2027	5446	0,88	52,8	3167	4139	1,49	89,2	5352	3001
2,90	0,33	19,7	1181	8281	0,58	35,0	2099	5802	0,91	54,7	3280	4409	1,54	92,4	5543	3198
3,00	0,34	20,4	1221	8801	0,60	36,2	2171	6168	0,94	56,5	3393	4688	1,59	95,6	5734	3401
3,50	0,40	23,8	1425	11622	0,70	42,2	2533	8151	1,10	66,0	3958	6199	1,86	111,5	6690	4499
4,00	0,45	27,1	1629	14800	0,80	48,3	2895	10386	1,26	75,4	4524	7902	2,12	127,4	7645	5739
4,50	0,51	30,5	1832	18330	0,90	54,3	3257	12870	1,41	84,8	5089	9795	2,39	143,4	8601	7117
5,00	0,57	33,9	2036	22207	1,01	60,3	3619	15599	1,57	94,2	5655	11877	2,65	159,3	9557	8632

Pressure loss table for HERZ-composite pipe PE-RT/Al/PE-RT

w	40 x 3,5 mm				50 x 4 mm				63 x 4,5 mm				75 x 5 mm			
	Vs	Vs	Vs	R	Vs	Vs	Vs	R	Vs	Vs	Vs	R	Vs	Vs	Vs	R
m/s	l/s	l/min	l/h	Pa/m	l/s	l/min	l/h	Pa/m	l/s	l/min	l/h	Pa/m	l/s	l/min	l/h	Pa/m
0,10	0,09	5,1	308	6	0,14	8,3	499	5	0,23	13,7	824	3	0,33	19,9	1195	3
0,15	0,13	7,7	462	13	0,21	12,5	748	9	0,34	20,6	1237	7	0,50	29,9	1792	5
0,20	0,17	10,3	616	21	0,28	16,6	998	15	0,46	27,5	1649	11	0,66	39,8	2389	9
0,25	0,21	12,8	770	31	0,35	20,8	1247	23	0,57	34,4	2061	17	0,83	49,8	2986	13
0,30	0,26	15,4	924	42	0,42	24,9	1496	31	0,69	41,2	2473	23	1,00	59,7	3584	18
0,35	0,30	18,0	1078	56	0,48	29,1	1746	41	0,80	48,1	2886	30	1,16	69,7	4181	24
0,40	0,34	20,5	1232	70	0,55	33,3	1995	52	0,92	55,0	3298	38	1,33	79,6	4778	30
0,45	0,38	23,1	1386	86	0,62	37,4	2244	64	1,03	61,8	3710	47	1,49	89,6	5376	37
0,50	0,43	25,7	1540	104	0,69	41,6	2494	77	1,15	68,7	4122	56	1,66	99,5	5973	45
0,55	0,47	28,2	1693	123	0,76	45,7	2743	91	1,26	75,6	4535	66	1,83	109,5	6570	53
0,60	0,51	30,8	1847	143	0,83	49,9	2993	106	1,37	82,4	4947	78	1,99	119,5	7168	62
0,65	0,56	33,4	2001	165	0,90	54,0	3242	122	1,49	89,3	5359	89	2,16	129,4	7765	71
0,70	0,60	35,9	2155	188	0,97	58,2	3491	139	1,60	96,2	5771	102	2,32	139,4	8362	81
0,75	0,64	38,5	2309	212	1,04	62,3	3741	157	1,72	103,1	6184	115	2,49	149,3	8959	92
0,80	0,68	41,1	2463	238	1,11	66,5	3990	176	1,83	109,9	6596	129	2,65	159,3	9557	103
0,85	0,73	43,6	2617	265	1,18	70,7	4239	196	1,95	116,8	7008	144	2,82	169,2	10154	115
0,90	0,77	46,2	2771	293	1,25	74,8	4489	217	2,06	123,7	7420	160	2,99	179,2	10751	127
0,95	0,81	48,8	2925	322	1,32	79,0	4738	239	2,18	130,5	7833	176	3,15	189,1	11349	140
1,00	0,86	51,3	3079	353	1,39	83,1	4988	262	2,29	137,4	8245	193	3,32	199,1	11946	154
1,10	0,94	56,4	3387	418	1,52	91,4	5486	311	2,52	151,2	9069	229	3,65	219,0	13140	182
1,20	1,03	61,6	3695	489	1,66	99,8	5985	363	2,75	164,9	9894	267	3,98	238,9	14335	213
1,30	1,11	66,7	4003	564	1,80	108,1	6484	419	2,98	178,6	10718	308	4,31	258,8	15530	246
1,40	1,20	71,8	4311	644	1,94	116,4	6983	479	3,21	192,4	11543	352	4,65	278,7	16724	281
1,50	1,28	77,0	4619	728	2,08	124,7	7481	542	3,44	206,1	12367	399	4,98	298,6	17919	319
1,60	1,37	82,1	4927	818	2,22	133,0	7980	609	3,66	219,9	13192	448	5,31	318,6	19113	358
1,70	1,45	87,2	5234	912	2,36	141,3	8479	679	3,89	233,6	14016	500	5,64	338,5	20308	399
1,80	1,54	92,4	5542	1010	2,49	149,6	8978	753	4,12	247,3	14841	554	5,97	358,4	21503	443
1,90	1,63	97,5	5850	1114	2,63	157,9	9476	830	4,35	261,1	15665	611	6,30	378,3	22697	488
2,00	1,71	102,6	6158	1221	2,77	166,3	9975	910	4,58	274,8	16490	671	6,64	398,2	23892	536
2,10	1,80	107,8	6466	1334	2,91	174,6	10474	994	4,81	288,6	17314	733	6,97	418,1	25086	586
2,20	1,88	112,9	6774	1450	3,05	182,9	10973	1081	5,04	302,3	18139	797	7,30	438,0	26281	637
2,30	1,97	118,0	7082	1572	3,19	191,2	11471	1172	5,27	316,1	18963	864	7,63	457,9	27476	691
2,40	2,05	123,2	7390	1697	3,33	199,5	11970	1266	5,50	329,8	19788	934	7,96	477,8	28670	746
2,50	2,14	128,3	7698	1828	3,46	207,8	12469	1363	5,73	343,5	20612	1006	8,30	497,7	29865	804
2,60	2,22	133,4	8006	1962	3,60	216,1	12968	1464	5,95	357,3	21436	1080	8,63	517,7	31059	864
2,70	2,31	138,6	8314	2101	3,74	224,4	13466	1567	6,18	371,0	22261	1157	8,96	537,6	32254	925
2,80	2,39	143,7	8621	2244	3,88	232,8	13965	1675	6,41	384,8	23085	1236	9,29	557,5	33449	988
2,90	2,48	148,8	8929	2392	4,02	241,1	14464	1785	6,64	398,5	23910	1317	9,62	577,4	34643	1054
3,00	2,57	154,0	9237	2544	4,16	249,4	14963	1898	6,87	412,2	24734	1401	9,95	597,3	35838	1121
3,50	2,99	179,6	10777	3367	4,85	290,9	17457	2515	8,02	480,9	28857	1857	11,61	696,8	41811	1486
4,00	3,42	205,3	12316	4297	5,54	332,5	19950	3210	9,16	549,7	32979	2372	13,27	796,4	47784	1899
4,50	3,85	230,9	13856	5330	6,23	374,1	22444	3984	10,31	618,4	37102	2945	14,93	895,9	53757	2358
5,00	4,28	256,6	15395	6467	6,93	415,6	24938	4835	11,45	687,1	41224	3575	16,59	995,5	59730	2863

☑ Recycling and disposal

Both the pipes and press fittings and the corresponding transport packaging largely consist of raw materials suitable for recycling.

Your pipes and press fittings are not suitable for disposal with household waste. Ensure that your device and any available accessories are submitted for appropriate disposal.

☑ Material

HERZ uses high quality brass. Brass parts that are declared suitable for drinking water comply with the UBA and 4MS standards. The brass components are characterized by their good strength and excellent corrosion resistance.

Pursuant to Article 33 of the REACH Regulation (EC No. 1907/2006), we are obliged to point out that the material lead is listed on the SVHC list and that all brass components manufactured in our products exceed 0.1 % (w / w) lead (CAS: 7439-92-1 / EINECS: 231-100-4). Since lead is a component part of an alloy, actual exposure is not possible and therefore no additional information on safe use is necessary.